



1 lockers



2 shelving



3 cupboards & work stations



4 mobile shelving



5 technic shelving



6 cloakroom



7 cabinets

All Probe products are available from a wide network of authorised Probe dealers

5

PR OBE

technic cantilever

5



MEETS BS 4875-7: 2006 PART 7 AND BS 4875-8: 1998 PART 8





□ SINGLE SIDED BAYS

flexible storage space



- library
- office
- education
- reference
- retail



PROBE

technic shelving



MEETS BS 4875-7: 2006 PART 7
AND BS 4875-8: 1998 PART 8



99.9% REDUCTION OF MRSA, E-COLI & BACTERIA
Antimicrobial efficiency will continue for the life of the coating.

versatile & stylish

TECHNIC SHELVING

This versatile shelving system offers a wide range of specialist shelves and accessories to suit your business. Technic shelving can be quickly adapted to meet your changing needs and is quick and easy to construct, saving down time and minimising disturbance.

- **WALL MOUNTED BAYS**
Available in five heights, see overleaf.



SHELF PROFILE

Technic shelves have been designed with a rolled front face adding strength and allowing for display strips to be inserted.

SHELF OPTIONS

A wide range of shelf options has been made available to suit your needs, all available in three widths, 750, 900 and 1000mm. See pages 6 & 7 for details.

A STYLISH SYSTEM

A stylish system well suited to your environment.

5 HEIGHT OPTIONS

Wall Bars are available in five heights 1030, 1380, 1680, 2030 & 2530mm.
Note: Free standing uprights available in different heights, see opposite.

SHELF ADJUSTMENT

Shelves can be raised or lowered by 25mm increments making this system extremely versatile.

- **QUICK BUILD SYSTEM**
Technic shelving can be adjusted as quickly as it can be built.



PROBE ACTIVECOAT DEVELOPED IN CONJUNCTION WITH DUPONT

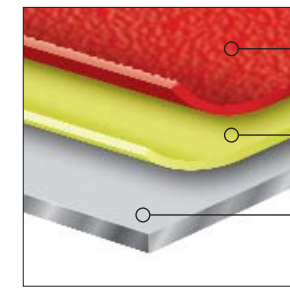

AC+IVECOAT®

The hard wearing anti-bacterial powder coating for the most stringent hygienic environment.

IRON PHOSPHATE KEY COAT

This anti-rust, key coat bonds to the steel in readiness for the final active coating.

PREPARED STEEL SURFACE

Chemical cleaning ensures an ideal surface for further coatings.



The miracles of science™

- **SINGLE SIDED BAYS**

UPRIGHTS

This versatile system includes single & double sided floorstanding uprights, wall mounted & wheel mounted uprights. All uprights allow for quick and easy adjustment of shelves in increments of 25mm.

5 HEIGHT OPTIONS

Free standing uprights available in five heights 1200, 1500, 1800, 2100 & 2300mm. See pages 6 & 7 for details.
Note: Wall Bars available in different heights, see opposite.

REMOVABLE BACKSTOP

These clear plastic backstops can be easily removed if required.

FEATURES & BENEFITS

- Anti-slip finish on shelves.
- Full range of optional accessories.
- Adjustable feet (except wall & wheel mounted units).
- Elegant and sturdy construction
- A quick and easy to build system
- Available in a wide range of colours
- Vertical support for Books, folders etc

AVAILABLE COLOURS

All Technic units are powder coated with AC+IVECOAT® exclusive to Probe.



PROBE

technic shelving



MEETS BS 4875-7: 2006 PART 7
AND BS 4875-8: 1998 PART 8

ACTIVECOAT®
anti-bacterial technology

99.9% REDUCTION OF MRSA, E-COLI & BACTERIA
Antimicrobial efficiency will continue for the life of the coating.





For your piece of mind, Probe Technic Shelving has passed the following British Standards for strength and rigidity:

BS 4875-7: 2006 PART 7 & BS 4875-8: 1998 PART 8

options & specifications

WHEEL MOUNTED

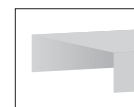

SHELF INFILL

Fits between Canopy/Standard shelves creating a continuous surface from front to back.

HANDLE

SLIDING BOOK SUPPORT

Available in to heights: 200 & 280mm

CASTORS

Castor sets including 2 standard and 2 braked wheels are available, enabling the shelving to be moved easily.

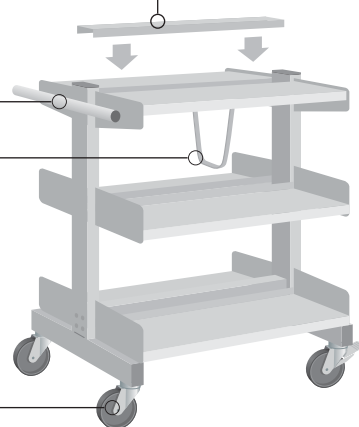

STANDARD

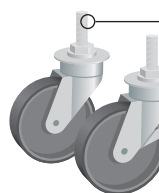

BRAKED

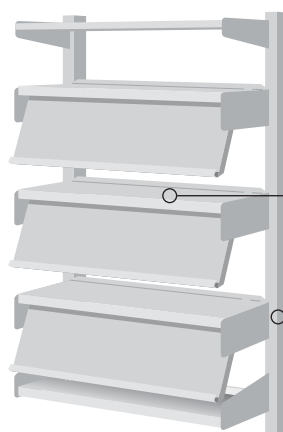

WALL MOUNTED

ALL SHELVES AVAILABLE

Pictured with 3 Display & Storage shelves, a Flush/Canopy shelf and Standard shelf.

FIVE HEIGHTS

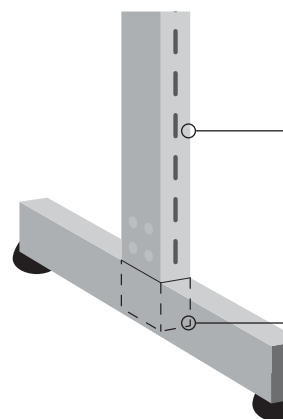

UPRIGHTS

70 x 30mm Upright slots into cross bar for added stability.

UPRIGHT CROSS BAR

60 x 40 Cross bar has been machined to accept upright.

DOUBLE SIDED BAY



FLUSH/CANOPY SHELF

Placed at the top and bottom of the upright they provide fixings for the Decor End Panel.

DISPLAY SHELF

TAPE CASSETTE SHELF

DVD/CD/VIDEO SHELF

STANDARD SHELF



aisle end display

GUIDE STRIP DISPLAY

Guide Strip slides into front profile of shelf. 40mm & 70mm high versions available.

SLIDING BOOK SUPPORT

Available in to heights: 200 & 280mm

DISPLAY & STORAGE SHELF

STANDARD SHELF

CASTORS



FLUSH/CANOPY SHELF

Used at the top of this system to maximise storage space.

Available in three widths: 750, 900 & 1000mm. UDL 65Kg



DISPLAY & STORAGE SHELF

This shelf is similar to the display shelf with the added facility to store a number of displayed items.

Available in three widths: 750, 900 & 1000mm. UDL 65Kg

REMOVABLE CLEAR PLASTIC BACK STOP

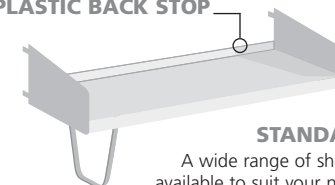

STANDARD SHELF

A wide range of shelf options are available to suit your needs. Standard shelf comes with clear plastic back stop.

Pictured with optional Sliding Book Support. Available in three widths: 750, 900 & 1000mm. UDL 65Kg



DISPLAY SHELF

Display documents, brochures and products.

Available in three widths: 750, 900 & 1000mm. UDL 65Kg



TAPE/VIDEO CASSETTE OR CD/DVD SHELF

Width: 900mm. UDL 65Kg



CONVERSION BRACKET

The conversion bracket can be used to adapt a standard shelf into a display shelf.

maximum bay loading 500kg

dependent on specification

MAXIMUM SHELF LOADING (UNIFORMLY DISTRIBUTED)		
SHELF	WIDTH(mm)	UDL
Flush/Canopy Shelf	750	65kg
	900	65kg
	1000	65kg
Shelf depths available: 200 250 300 350 (mm)		
Standard Shelf	750	65kg
	900	65kg
	1000	65kg
Shelf depths available: 200 250 300 350 (mm)		
Display Shelf	750 x 350	65kg
	900 x 350	65kg
	1000 x 350	65kg
Tape Cassette Shelf	900	65kg
Video or CD/DVD Shelf	900	65kg
Display & Storage Shelf	750 x 350	65kg
	900 x 350	65kg
	1000 x 350	65kg

heights

SINGLE & DOUBLE SIDED BAYS

HEIGHT (mm) UPRIGHTS	WIDTHS (mm) SHELF
1200	750
1500	
1800	
2100	
2300	
	900
	1000

WALL BARS

HEIGHT (mm) UPRIGHTS	WIDTHS (mm) SHELF
1030	750
1380	
1680	
2030	
2530	
	900
	1000



99.9% REDUCTION OF MRSA, E-COLI & BACTERIA
Antimicrobial efficiency will continue for the life of the coating.



technic shelving



MEETS BS 4875-7: 2006 PART 7
AND BS 4875-8: 1998 PART 8